



**CALL TODAY TO
ARRANGE YOUR
FREE NO OBLIGATION
DEMONSTRATION
+44 0 1246 811475**



CONTENTS

- 3 Risks of manual handling
- 4 Knuckle Joint SwingLift
- 6 MiniLoader SwingLift
- 8 Foldaway 500 SwingLift
- 10 FV500 SwingLift
- 12 Introduction to PH cranes
- 14 PH110 crane
- 16 PH150 crane
- 18 PH mid-range cranes
- 20 PH heavy duty cranes
- 22 LoadLift platform lifts
- 24 The Configurator
- 25 Spares & Accessories eShop
- 26 One-stop-shop
- 28 Service options
- 30 Winches
- 31 Working with ALLMI to implement safe practices

OUR ACCREDITED PARTNERS



WELCOME

Penny Hydraulics vehicle mounted lifting equipment is designed to reduce the risk of manual handling related injuries and to increase the efficiency of your workforce.

Our range comprises SwingLift cranes, hydraulic PH cranes, hydraulic loading platforms as well as winches and hoists. When mounted to your van, flatbed truck or trailer our lifts enable drivers to move heavy and bulky items on and off the vehicle easily, safely and efficiently.

Health & Safety is paramount for all businesses, which is why all Penny Hydraulics cranes and loading platforms are designed, developed and manufactured to stringent quality and safety standards.

Unleash the potential of your vehicle and workforce by introducing a Penny Hydraulics crane or loading platform and increase productivity and job capability.

In this brochure we will introduce you to the features and benefits of our range, and help you to understand which lifting solution is best for you.

APPROVED CONVERTERS FOR





SWINGLIFT



PH CRANES



LOADLIFT



**BUILD YOUR OWN
LIFT USING THE
CONFIGURATOR –
PENNYHYDRAULICS.COM**

RISKS OF MANUAL HANDLING

1 in 3 accidents at work are caused by manual handling – help reduce the risk to your workforce.

Manual handling plays a large part in a whole host of industries, from construction to healthcare. But lifting and carrying heavy loads can be dangerous if all of the relevant regulations aren't followed, the conditions are less than ideal, or staff aren't trained to carry out manual handling tasks in the safest way possible.

The HSE states that a massive 1 in 3 accidents at work are caused by manual handling. The introduction of a mechanical lifting aid such as a crane or hydraulic loading platform can eliminate the human requirement for heavy lifting.

The benefits of vehicle mounted lifting equipment do not end with health and safety. The introduction of a crane or loading platform allows your workforce to expand their capabilities and increase their productivity. A crane or loading platform can reduce a two- or three-person task to a single-person task, saving you money and allowing you to utilise your workforce more effectively.

1 in 3
accidents
at work
are caused
by manual
handling

50%
chance of a
back injury
recurring
within 12
months

£8k
average
cost of
a back
injury to
employers



CALL TODAY TO ARRANGE
YOUR FREE, NO OBLIGATION
DEMONSTRATION -
+44 0 1246 811475

250kg
maximum
working
load

low crane
weight
from
22kg

2m
maximum
boom length



KNUCKLE JOINT SWINGLIFT CRANES

The flexible SwingLift crane that offers a complete handling solution.

Combining simplicity, reliability and proven durability the Knuckle Joint range of cranes provides a safe, efficient and cost-effective means of handling loads for all types of vehicle.

KEY FEATURES & BENEFITS

- **Lifts up to 250kg** enabling your team to move heavy items with ease
- **Boom plus two pivot points** means the operator can carry out lifts within 2-4m arc (model specific)
- **Overload device** limits lifts to the maximum working load of the crane, protecting your vehicle and workforce from accidents
- **Low crane weight** takes little away from the payload of the vehicle
- **Compact design** maximises the space available for storage
- **Demountable fitting** means the crane can be transferred between vehicles, giving you full fleet flexibility

Model	Maximum working load kg	Crane weight kg	Boom length mm	RCL	Demountable
KJ250/1	250	27	1000	✓	✓
KJ250/1.5	250	22	1500	✓	✓
KJ250/2 GHT	250	50	2000	✓	✓
KJ250/2 RPT	250	100	2000	✓	X





MINILOADER SWINGLIFT CRANES

Small and mighty – the perfect lifting solution for your pickup or van fleet.

Our range of MiniLoader cranes are lightweight, compact, easily demountable and powerful with a maximum working load of 250 or 500kg. Ideal for vans and pickups with limited space, the boom length options offer a range of cost-effective lifting solutions.

KEY FEATURES & BENEFITS

- **Lifts 250-500kg** dependent on model
- **3 height extensions** give you complete lifting flexibility
- **Easy to use** manual boom positioning and electric hoist control
- **Overload device** limits lifts to the maximum working load of the crane, protecting your vehicle and workforce from accidents
- **Low crane weight** from just 23kg, and a compact design which takes up just 34cm of usable space when stowed
- **Demountable fitting** means the crane can be transferred between vehicles, giving you full fleet flexibility – can be pillar mounted to the floor or corner bracket mounted to the headboard

Model	Maximum working load kg	Crane weight kg	Boom length mm	Overload device	Demountable
ML250 Pickup	250	23	980	✓	✓
ML250 Van	250	23	960	✓	✓
ML500LB Pickup	500	48	1640	✓	✓
ML500LB Van	500	48	1610	✓	✓
ML500SB Van	500	44	1090	✓	✓

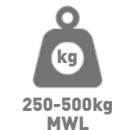



BUILD YOUR OWN
MINILOADER USING
THE CONFIGURATOR -
PENNYHYDRAULICS.COM

3
height
extensions
for complete
flexibility

low crane
weight
from
23kg

takes up just
34cm
of usable
load space



CALL TODAY TO ARRANGE
YOUR FREE, NO OBLIGATION
DEMONSTRATION -
+44 0 1246 811475

low crane
weight of
75kg

360°
slewing
rotation

500kg
maximum
working
load



FOLDAWAY 500

SWINGLIFT CRANE

Experience 500kg lifting capability with full 360 degree slewing access.

The Foldaway 500 is a compact, 500kg capacity crane for pickups, dropsides and box bodies, ideally suited where space and payload are at a premium.

KEY FEATURES & BENEFITS

- **Lifts 500kg**
- **3 height extensions** up to 2m from the base of the crane
- **Easy to use** manual boom positioning and electric hoist control using wander lead
- **Overload device** limits lifts to the maximum working load of the crane, protecting your vehicle and workforce from accidents
- **Low crane weight** of 75kg
- **Compact design** takes up just 44cm of usable space in its stowed position

Model	Maximum working load kg	Crane weight kg	Boom length mm	RCL	Demountable
F500	500	75	1470	✓	✗





FV500

SWINGLIFT CRANE

Fully hydraulic 500kg capacity crane perfect for precise and safe handling.

The FV500 can be fitted to both vans and pickups and is perfect for a wide range of applications providing reliable and flexible load handling solutions. Its 500kg heavy duty hoist allows vertical below ground work ideal for local authorities, highways and utilities.

KEY FEATURES & BENEFITS

- **Lifts 500kg**
- **Fully hydraulic boom raise** to more than 2m from the base of the crane
- **Easy to use** remote control hydraulic lift, slew, extension and electric hoist
- **Overload device** limits lifts to the maximum working load of the crane, protecting your vehicle and workforce from accidents
- **Low crane weight** of 95-119kg
- **Compact design** integral oil tank and motor pump unit maximises load space

Model	Maximum working load kg	Crane weight kg	Boom length mm	RCL	Demountable
FV500 Van	500	95	1190	✓	✗
FV500 Pickup	500	119	1500	✓	✗



BUILD YOUR OWN
FV500 USING
THE CONFIGURATOR -
PENNYHYDRAULICS.COM

500kg
maximum
working
load

low crane
weight
from
95kg

1.5m
maximum
boom length





PH CRANES

SAFETY FOR THE FUTURE

All PH cranes now incorporate full hydraulic control for even the lightest units. Hydraulic control prevents the need to access the bed of the vehicle and helps ensure smooth and precise load handling with reduced risk of the sudden and unexpected movements that can cause accidents to users and bystanders. These features are now widely available on cranes with maximum working loads from just 200kg upwards. The use of proportional controls, another recent innovation on smaller cranes, helps to ensure precise and controlled movements which promotes even greater safety.

Remote controls are also becoming more popular. These are especially useful from a safety point of view because they reduce the need for operators to stand in close proximity of the load thereby increasing operator safety. Two types of control are available. The first is attached to the crane by a length of cable known as a wander lead while the second is a wireless device that provides the user with complete autonomy, enabling them to stand in a safe position with the best all-round view of the working area.



**CALL TODAY TO ARRANGE
YOUR FREE, NO OBLIGATION
DEMONSTRATION -
+44 0 1246 811475**

Another trend in crane design is to remove weight without compromising on performance and safety. Penny Hydraulics uses its in-house advanced CAD and finite element analysis tools to re-engineer its range to reduce weight through optimised design and use of alternative materials which replace some mild steel components with higher grade steels or lighter alloys. Operators can now install one of these devices with reduced impact on the overall vehicle weight to leave more carrying capacity for improved operational flexibility and productivity.

Although this helps with all types of vehicle it is especially useful for those in the 3.5t and 7.5t classes where remaining within the overall weight and carrying capacity limits are always of concern to operators.

PH cranes are manufactured from the latest high quality steels, including Domex and Weldox. This means that the crane structures are high strength and durable yet lightweight, helping to reduce emissions and maximise fuel economy and payload.

**MWL up to
3300kg**

**boom
length up to
6.8m**

**crane weight
as low as
83kg**



PH110

HYDRAULIC CRANE

Up to 990kg lifting capacity on this small but strong crane.

An extremely compact crane with a very low self-weight, from only 105kg. This robust little crane only stands 1.2 metres tall but has a maximum outreach of up to 4.5 metres.

KEY FEATURES & BENEFITS

- **2.80-4.5 metre** standard reach
- **Electronic Capacity Indicator (ECI)**
- **180-330°** slewing rotation
- **3 function valve bank** provides smooth and precise control
- **Motor pump kit** with 5 litre oil tank for electric versions and 15 litre tank for PTO (Power Take Off) versions
- **Demountable** with counter flange

Model	Maximum working load kg	Crane weight kg	Boom length mm	RCL	Demountable
PH110	990	105-175	4500	✓	✓

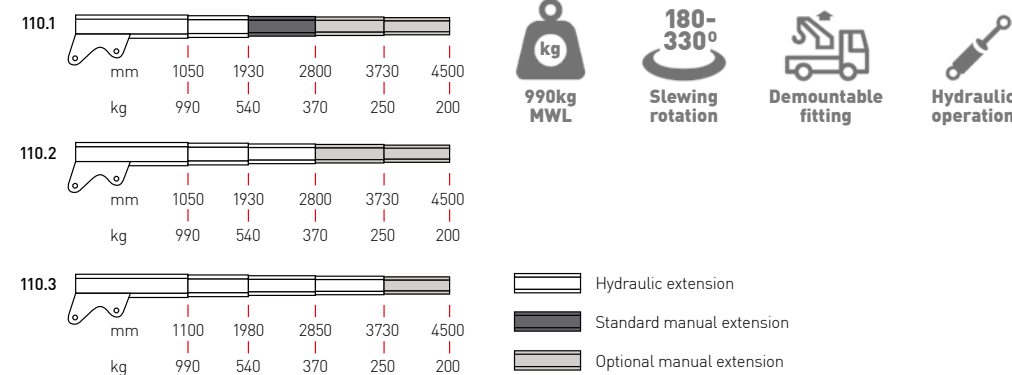

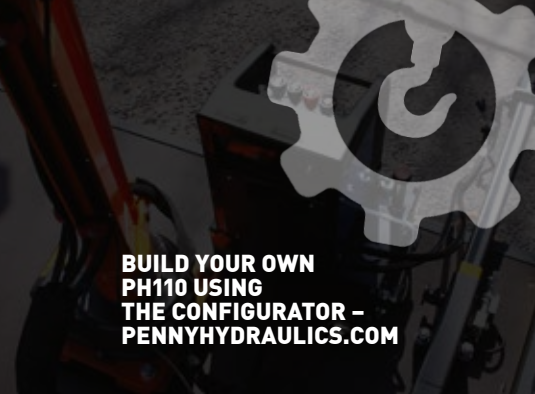

BUILD YOUR OWN
PH110 USING
THE CONFIGURATOR -
PENNYHYDRAULICS.COM

**180-
330°**
slewing
rotation

4.5m
maximum
reach

MWL up to
990kg



Also
available
PH50



A small, lightweight (from 83kg), compact, 0.5tm crane with a wide range of variations to suit most applications including pick-ups, vans, ATVs and trailers.

Find out more at www.pennyhydraulics.com



CALL TODAY TO ARRANGE
YOUR FREE, NO OBLIGATION
DEMONSTRATION -
+44 0 1246 811475

**180-
330°**
slewing
rotation

5m
maximum
boom
length

MWL
1300kg





PH150 HYDRAULIC CRANE

Up to 1300kg lifting capacity with up to 5 metres reach for this popular hydraulic crane.

A lightweight crane from 165kg that can be supplied with stability monitoring systems ECI, optional LLC or LME04 to comply with current legislation.

KEY FEATURES & BENEFITS

- Lifts 1300kg
- 3-4 metre standard reach
- **Electronic Capacity Indicator (ECI)**
- 180–330° slewing rotation
- 4 function valve bank provides smooth and precise control
- **Motor pump kit** with 11 litre oil tank for electric versions and 15 litre tank for PTO (Power Take Off) versions

Model	Maximum working load kg	Crane weight kg	Boom length mm	RCL	Demountable
PH150	1300	165	5000	✓	✗

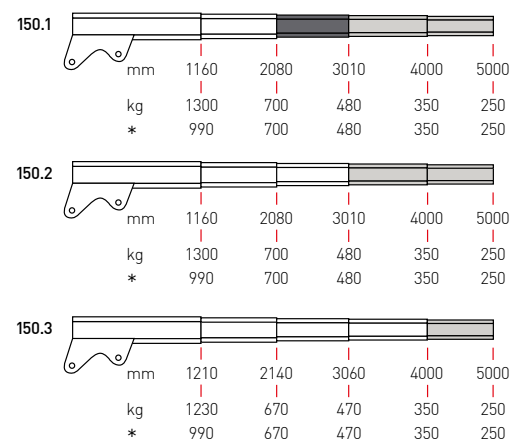

1300kg MWL

180-330°
Slewing rotation

Hydraulic operation

Hydraulic extension
 Standard manual extension
 Optional manual extension

* "D" version



PH MID-RANGE HYDRAULIC CRANES

These mid-range cranes offer big lifting and loading capabilities for 3.5 tonne vehicles.

Model	Maximum working load kg	Crane weight kg	Boom length mm	RCL	Demountable
PH180	1500	180	5000	✓	✗
PH230	1800	225	5200	✓	✗
PH270	2150	225	5200	✓	✗
PH270L	1870	235	6000	✓	✗

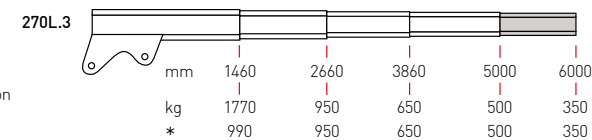
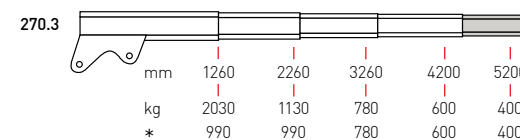
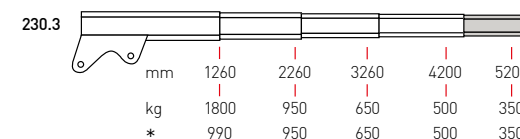
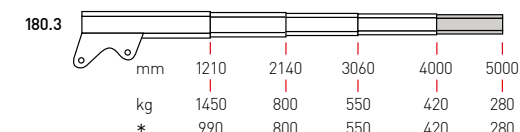
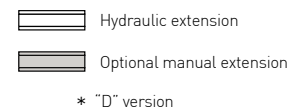

Example boom configurations shown above
Details of other boom variants available on our website



BUILD YOUR OWN
PH MID-RANGE CRANE
USING THE CONFIGURATOR -
PENNYHYDRAULICS.COM

**180-
360°**
slewing
rotation

6m
maximum
boom
length

2150kg
maximum
working
load





CALL TODAY TO ARRANGE
YOUR FREE, NO OBLIGATION
DEMONSTRATION -
+44 0 1246 811475

Ideal for
7.5
tonne
vehicles

6.8m
maximum
boom
length

3300kg
maximum
working
load



PH HEAVY DUTY HYDRAULIC CRANES

These heavy duty cranes offer serious lifting power and are best suited to 7.5 tonne vehicles and above.

Model	Maximum working load kg	Crane weight kg	Boom length mm	RCL	Marinised
PH330	2500	270	6360	✓	✗
PH380	2650	310	6790	✓	✗
PH400	2650	460	6750	✓	✓
PH500	3300	470	6750	✓	✓
PH510	3300	465	6830	✓	✓

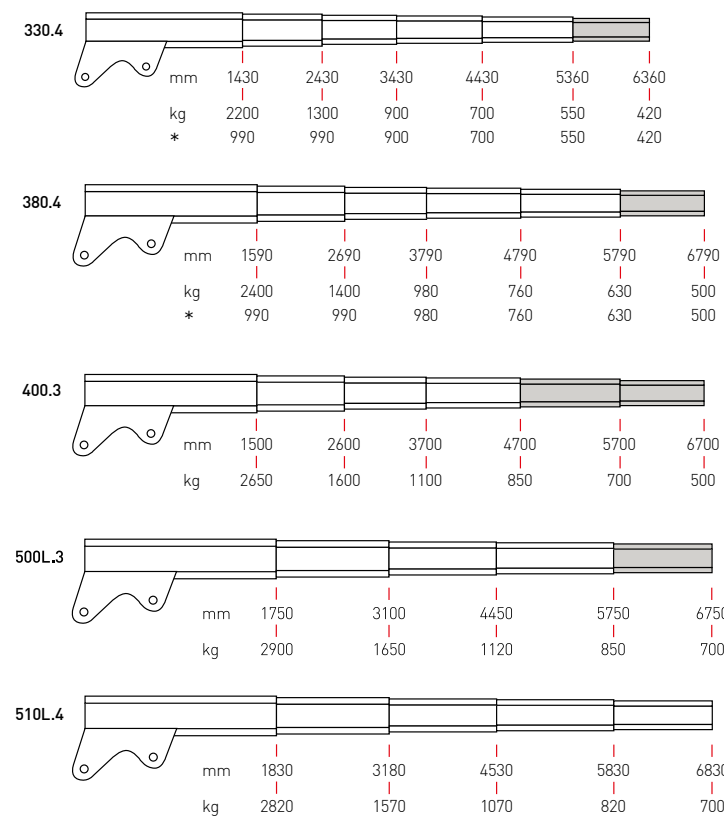
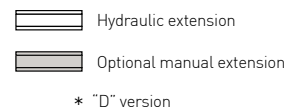

Example boom configurations shown above
Details of other boom variants available on our website

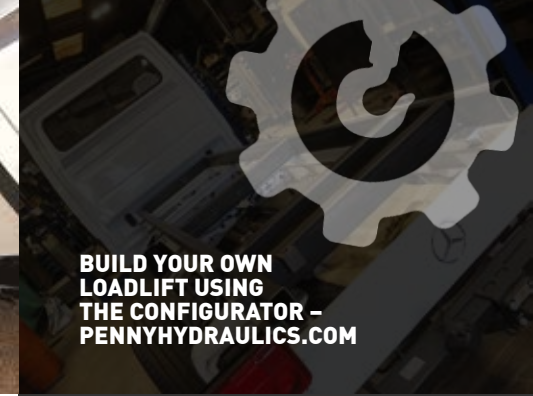

LOADLIFT

HYDRAULIC LIFTING PLATFORMS

The hydraulic lifting platform that can be tailor made to suit your lifting requirements.

Businesses are increasingly choosing LoadLifts with a bespoke platform to move their products safely and efficiently.

Like many products in the Penny Hydraulics product range, the LoadLift has developed as customers bring problems to us and we innovate to solve them. Over the many years that we have been supplying LoadLifts to customers around the world, we have made modifications including:

- **Bespoke platform size** enabling you to lift larger items, taking into account the clearance needed for the van
- **Increased capacity** to lift designated amounts, uprating the lifting performance of the lift to ensure heavier loads can be moved
- **Automatic roll stops (with manual override)** that operate to keep the product secure whilst moving from the floor onto the van
- **Fixing points** to strap and secure tall products such as gas bottles
- **Single wheel lifts** with a roll-on/roll-off locking device, ideal for large vehicle tyres and re-grooving at the roadside

We also offer a range of SideLift side-mounted lifts – find out more on our website.

low
self-weight
from
60kg

up to
500kg
maximum
working load

only **1**
operator
required



KEY FEATURES & BENEFITS

- **Compact and foldaway design** has little impact on the capacity of your van
- **Can be installed into the full range of vans** bringing you fleet flexibility
- **Side door/rear door loading** giving you the flexibility to load/unload either kerbside or in a yard
- **Low self-weight (starting at just 60kg)** ensures minimum impact on payload
- **Lifts up to 250kg** with optional MWL upgrade up to 500kg dependent on the vehicle and fitting position
- **Mechanised lifting solution** removes the requirement to manually push/pull heavy loads up or down a ramp which has an incline, reducing the risk of accident and injury
- **Can be used by a single operator** meaning what was once a two-person job can now be achieved with one person bringing your workforce more capability



The Configurator is a free-to-use online tool designed to help you find the right crane

It works by asking a series of questions directly related to your needs

THE CONFIGURATOR PUTS YOU IN CONTROL

Want to add a lifting solution to your vehicle but not sure where to start? The Configurator has been designed to provide you with the information you need, easily and independently.

- 

Save time

Access the information you need quickly and easily, removing the need for phone calls or emails. The Configurator provides suggested lifting solutions for you to explore and learn more about.
- 

Easy to use

The Configurator's intuitive and user-friendly design helps you through the simple process and to the suggested solution.
- 

Need support?

Still not sure? Our friendly customer service team are on hand to help you with your enquiry – you can contact us on +44 0 1246 811475.
- 

Request a quotation and demonstration

You can request a quotation and demonstration directly through the Configurator, based on the lifting solution that has been suggested by your answers.



8 SIMPLE STEPS TO YOUR IDEAL LIFTING SOLUTION

TRY IT NOW!
[HTTPS://CONFIGURATOR.PENNYHYDRAULICS.COM/](https://configurator.pennyhydraulics.com/)

- 1. Enter your details**

- 2. Select your vehicle type**

- 3. Select your lifting method**

- 4. Select maximum weight**



- 5. Modify to meet your needs**

- 6. Select position of equipment**

- 7. Select any options**

- 8. Request a quotation or demonstration**

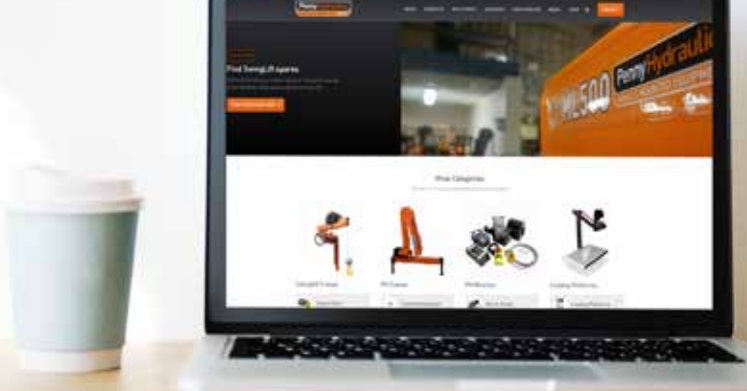



SPARES & ACCESSORIES eSHOP

SAVE 5% ON ORDERS PLACED ONLINE

Save time and money.

- **5% discount** applied to all orders
- **Easy to find items** using our exploded diagrams of cranes
- **Save time** by setting-up an account

Simple, user-friendly design.

- **Clear categories** help you navigate around the eShop
- **Prices available** without logging in
- **Vehicle mounted lifting equipment pages** link directly to spares and accessories shops

VISIT TODAY!

WWW.PENNYHYDRAULICS.COM/SHOP

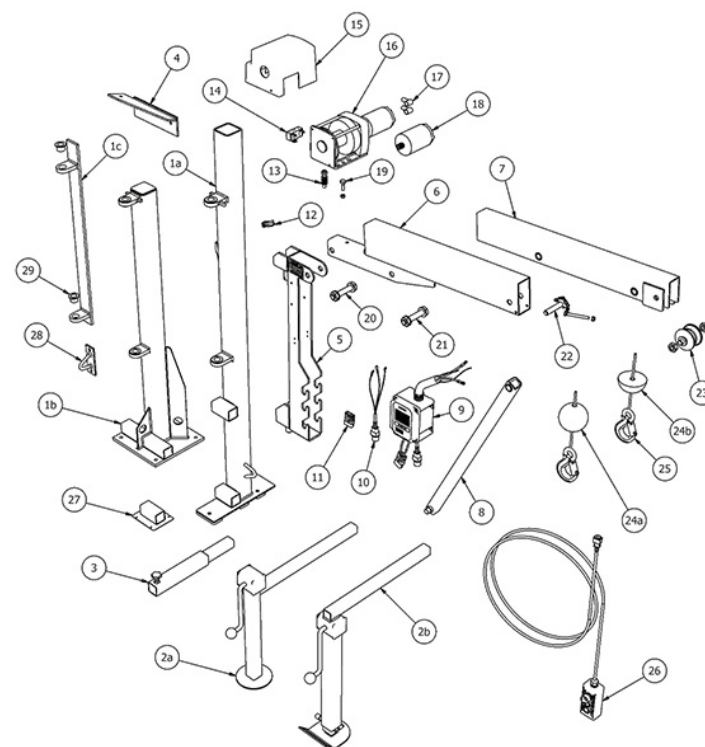



ONE-STOP-SHOP

A FULL SERVICE, ALL UNDER ONE ROOF

Each of our products comes complete with a comprehensive range of inclusive services.

Design

When fitting a lifting solution onto a vehicle overall payload is a key consideration. AutoCad allows us to tailor-make where applicable and helps keep additional weight to a minimum. Stress analysis software means the strength and stability of both lifting solution and vehicle is maintained.

Manufacture

Unlike many other companies, we manufacture the majority of our lifting equipment in the UK at our purpose-built facility in Derbyshire. This has many benefits for our customers – short lead times; high quality standards; and our ability to design and manufacture bespoke items.

Installation

Our factory has designated fitting areas with qualified, experienced fitters waiting to install your equipment to OEM standard. Before leaving the factory each piece of equipment is tested to ensure that safety regulations are met, and the vehicle weighed to ensure compliance with axle loadings.

Training

We offer familiarisation training as well as ALLMI (the Association of Lorry Loader Manufacturers & Importers) accredited training courses. ALLMI is the UK's only trade association exclusively dedicated to the manufacture, importation, servicing, testing and use of lorry loaders. A Penny Hydraulics training programme protects your business by ensuring it is fully compliant with lifting legislation.

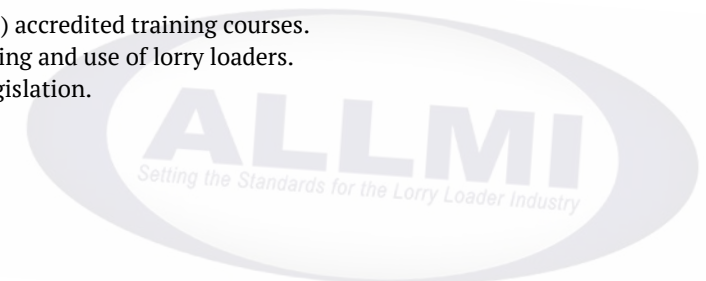



CALL TODAY TO ARRANGE
YOUR FREE, NO OBLIGATION
DEMONSTRATION -
+44 0 1246 811475

1000+
products
designed

10000+
products
made
& installed

40+
years
manufacturing
bespoke
solutions



SERVICE OPTIONS TO KEEP YOUR VEHICLE MOVING

12 month warranty

All Penny Hydraulics lifting equipment comes with a 12 month warranty as standard, unless otherwise stated.

Your legal obligations

You must make sure your lifting equipment is safe to ensure you adhere to current legislation; Provision and Use of Work Equipment Regulations 1998 (PUWER) and the Lifting Operations and Lifting Equipment Regulations 1998 (LOLER).

LOLER states that you must have lifting equipment thoroughly examined at least once in every 12 month period.

Thorough Examinations are not the same as routine maintenance. Routine maintenance typically involves checking and replacing worn or damaged parts, lubrication, replacing time-expired components, topping up fluid levels and making routine adjustments.

The benefits of regular servicing

Well-maintained equipment is more reliable and works better which leads to lower overall cost of ownership and fewer unscheduled breakdowns and working days lost.

Our nationwide team of service engineers provide planned maintenance and Statutory Thorough Examinations to minimise lifting equipment down time.

A planned maintenance agreement from Penny Hydraulics will help you fulfil your duty of care to employees and comply with your legal obligations and requirements.



BUILD YOUR OWN
LIFT USING THE
CONFIGURATOR -
PENNYHYDRAULICS.COM



Highly recommended by our customers

Penny Hydraulics prides itself on its level of service. We use the Net Promoter Score to track Customer Satisfaction. Our service team currently have a NPS score of 75%* – the average for manufacturing companies is 45%.

High first time fix rate

Our engineers provide a very high first time fix rate and can fit OEM replacement parts on-site supplied direct from our factory.

Penny Hydraulics offers a comprehensive set of planned maintenance programmes to ensure that its lifting equipment continues to provide safe and trouble-free performance over extended lifetimes with low overall cost of ownership.

Service agreements

Service agreements from Penny Hydraulics cover a minimum of one year and can include regular scheduled servicing and the compulsory annual checks that users of load handling equipment are required to complete under current legislation.

Parts and labour warranties

All-inclusive parts and labour warranties are available to match OEM vehicle specifications.

*March 2019

Ask about a
Service
Agreement

75%*
Net
Promoter
Score

12
month
warranty
as standard

40+
years
experience



WINCHES

THE LIGHTWEIGHT MOVING SOLUTION

Our lightweight, compact and quiet winches really pack a punch.

Weighing in at just 12kg PH winches offer between 3300lb and 6000lb line pull. This makes them extremely popular for the following applications:

- **Motorsport trailer applications**
- **Motorbike and quad recovery • Off-road adventures**
- **Boat and marine sport trailers • Hunting • Animal recovery**

Winch Packs

The complete solution to all your winching needs, the winch pack contains the core components to get you pulling.

Love the great outdoors? A PH winch is a perfect addition to motorsport trailers, boat trailers, caravans and much more.

If your hobby involves moving heavy items onto a trailer a PH winch is a perfect solution for you.



Buy now
on the
eShop



Accident Report Form
SECTION 1 PERSONAL DETAILS
GUIDANCE
The ticks 1, 2 and 3 to be completed immediately & representative of

ALLMI's core aims

- To promote the safe use of lorry loaders
- To ensure that the Association is involved in the formulation of any legislation which affects the industry's interests
- To promote compliance with training requirements embodied in current legislation

BUILD YOUR OWN LIFT USING THE CONFIGURATOR – PENNYHYDRAULICS.COM

WORKING WITH ALLMI TO IMPLEMENT SAFE PRACTICES

We have been members of ALLMI (Association of Lorry Loader Manufacturers and Importers) for over 30 years. Our Sales Director Richard Short is a member of the ALLMI board of Directors.

ALLMI was founded in 1978 at the request of the Health and Safety Executive, and it remains today as the UK's only trade association devoted exclusively to the lorry loader industry. It serves, represents and promotes the interests of its members and the industry at large, and it is the natural focus and authority on all issues involving the design, manufacture, application and use of lorry loaders.

Alongside ALLMI, it's been our mission to influence positive change across the LCV industry. 35% of all work-related illnesses are musculoskeletal disorders (MSDs)*. An MSD can affect muscles, joints and tendons in all parts of the body – they are often connected to incorrect manual handling. That equates to over 469,000 workers suffering from work-related MSDs in 2017/18 and over 6.6 million working days lost*.

Penny Hydraulics designs, manufactures, installs and maintains specialist lifting equipment to remove the requirement for manual handling. Lightweight, to maximise payload, yet powerful, and with a range of lifting capacities, our products are suitable for many applications.

We also offer ALLMI accredited training – if this is of interest, please get in touch.

*Labour Force Survey 2017/18

35% of all work-related illnesses are musculoskeletal disorders (MSDs)*

469,000 people suffer from work-related MSDs*

6.6 million working days lost*





Book a
**Free
demo**





Penny Hydraulics Limited
Station Road, Clowne, Chesterfield, Derbyshire S43 4AB, United Kingdom

Telephone +44 0 1246 811475 | Fax +44 0 1246 810403 | Email sales@pennyhydraulics.com | Website www.pennyhydraulics.com

 @PennyHydraulics

 @PennyHydraulics

 Pennyhydraulics

 Penny Hydraulics Ltd

 Penny Hydraulics Ltd

