

PH150.2

TECHNICAL DATA	PH150.2
Lifting capacity	14kNm
Max. lifting height from crane base	4000mm
Max. working slope	5°
Max. working pressure	210bar
Suggested oil flow	6-8l per min.
Electro-hydraulic power unit supply voltage	12V/24V
Max. absorption electro-hydraulic power unit (12V)	170A
Max. absorption electro-hydraulic power unit (24V)	85A
Hydraulic oil tank capacity (H version)	15l
Hydraulic oil tank capacity (electric version)	11l

CRANE WEIGHTS	kg
PH150.2	175-195
Base with extendable stabilisers	64-88
Beam with 2 extendable stabilisers	58-62

DIMENSIONS

CRANE	A	B1
PH 150.2	1360	690

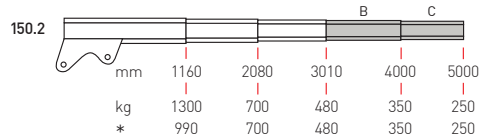
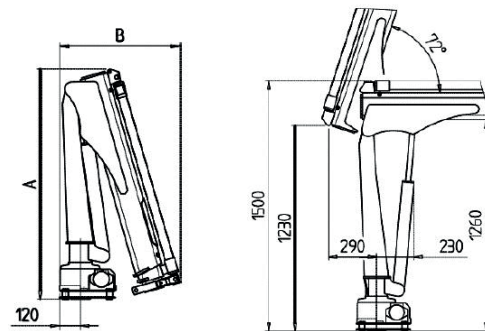

Hydraulic extension
 Standard manual extension
 B/C/D Optional manual extension
 * "D" version



Penny Hydraulics Limited

Station Road | Clowne | Chesterfield | Derbyshire | S43 4AB | United Kingdom
 t +44 (0) 1246 811475 | f +44 (0) 1246 810403

w www.pennyhydraulics.com | e sales@pennyhydraulics.com